



CAA/OT/KITALE/15412018-2019

24th June, 2019

To: All Tenderers

RE: PROPOSED PAVEMENTS REHABILITATION WORKS AT KITALE AIRSTRIP

TENDER No CAA/OT/KITALE/15412018-2019

ADDENDUM NO.2

The following are tender clarifications/addendum issued regarding the above tender in accordance to instructions to tenderers clause 7 of the bidding document for the referenced tender.

ITEM NO	INSTRUCTION	REMARKS
I.	Remove the entire book of drawings and replace with the attached drawings	Drawings attached

The closing/opening has been extended to **5th July 2019** from **27th June, 2019** at the same time and place as per our addendum No. 1.

Kindly amend your tender accordingly and ensure the tender is valid for **120 days** and the tender surety valid for **150 days** from the closing/opening date on **5th July 2019 at 11:00 a.m.**

Enclosed herein are the amended drawings.

The addendum forms part of the bidding document and is binding on all bidders. All other conditions remain the same.

Patrick K. Wanjuki
GM PROCUREMENT AND LOGISTICS
For: MANAGING DIRECTOR/CEO

NOTES

1. This drawing is protected under the copyright act and cannot be used or reproduced in part or in whole without author's consent.
2. All dimensions in mm unless stated should be read and not measured.
3. All construction work to comply with latest K.B.S. code of practice or BS, local authority By Laws and the regulation.
4. Contractors must verify all dimensions and levels before commencing work; any discrepancies should be reported to the architect/engineer before work commences.

REVISIONS	
Date	REVISION / ISSUE



KAA Kenya Airports Authority

P.O BOX 19001 - 00501 NAIROBI
 TEL: 822111/661000/641200
 FAX: 822079/827304
 Email: info@kenyaairports.co.ke
 Website: www.kenyaairports.co.ke

Project: **PROPOSED REHABILITATION WORKS AT KITALE AIRSTRIP**

Drawing Title: **STANDARD CULVERT DETAILS**

Drawn: **Nelson Obwoge**
 Checked: **Eng. Raphael Mukui**
 Approved: **Arch. Fred Odawo.**

GENERAL MANAGER (P&ES)

Date: May 2019.	NTS.
Project No. KAA/OT/KITALE/154/1/2018-2019	Drawing No. 010
Rev:	NORTH

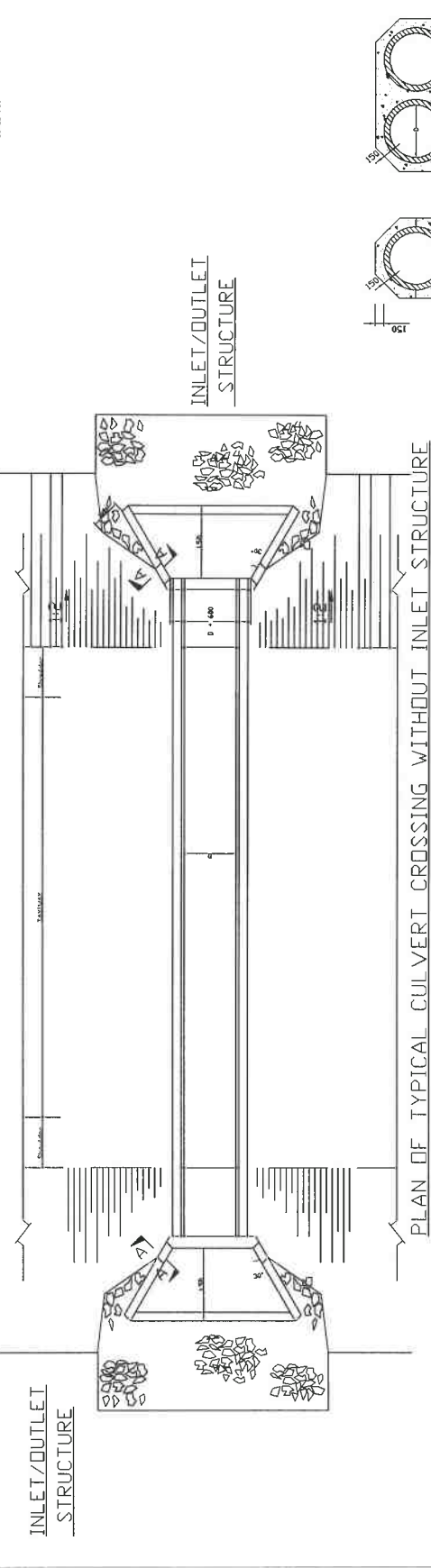
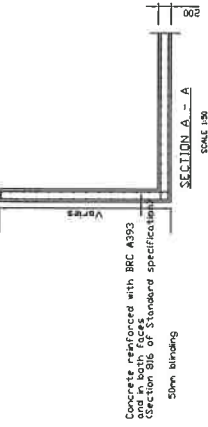
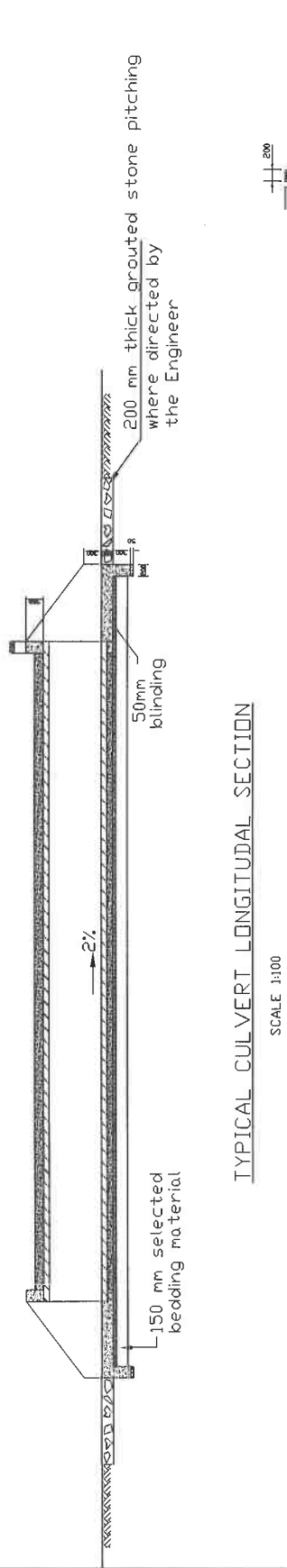

NOTE: (i) Length to be determined on site
 (ii) All dimensions are in mm unless otherwise stated

KAA/OT/KITALE/154/1/2018-2019

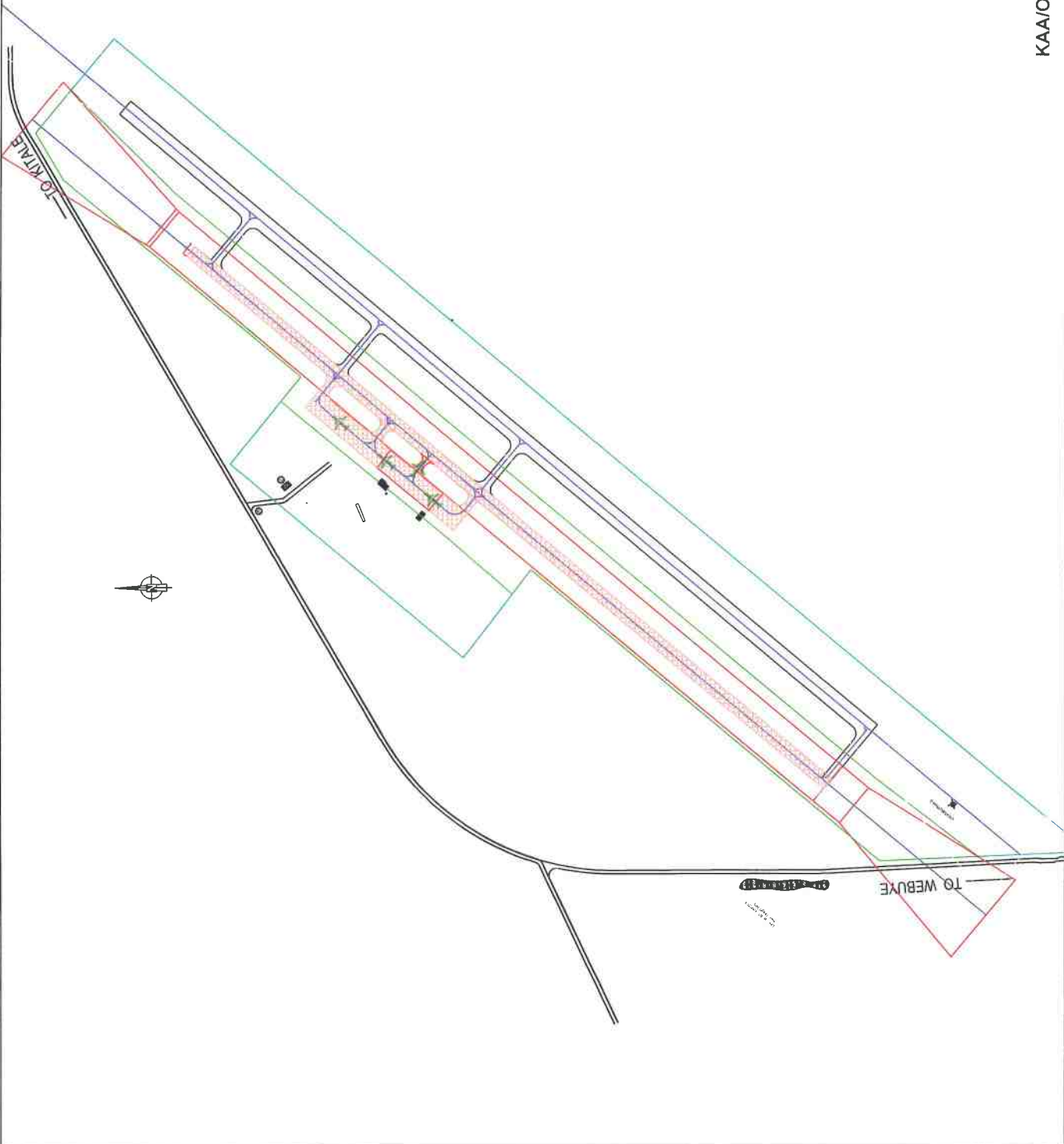

NOTES

1. This drawing is for information only. It is not to be used for construction purposes.
2. All dimensions are in meters unless otherwise stated.
3. All construction shall be carried out in accordance with the relevant standards and specifications of the relevant authorities.
4. Construction shall be carried out in accordance with the relevant standards and specifications of the relevant authorities.

REVISIONS	
NO.	REVISION



KAA Kenya Airports Authority
 P.O. Box 19001, Nairobi, Kenya
 Tel: +254 20 772 2000
 Fax: +254 20 772 2001
 Website: www.kaa.co.ke

PROPOSED REHABILITATION WORKS AT KITALE AIRSTRIP

Drawing No: **PROPOSED MASTER PLAN**
 Designed By: **Zablon, Onhwaka Nelson Obwoge**
 Checked: **Eng. Raphael Mukul**
 Approved: **Arch. Fred Odawo**

GENERAL MANAGER (P&ES)	
DATE	SCALE
May 2019	N/E
PROJECT NO.	DRAWING NO.
MAINTENANCE/OPERATIONS	001
REV.	REVISION

CAA/OT/KITALE/1541/2018-2019

NOTES

1. This drawing is protected by the copyright act and is not to be reproduced in part or in whole without author's consent.
2. All dimensions in mm unless stated should be read and not rounded.
3. All construction work to comply with latest K.E.S. Code of Practice and Kenya 5th Law and for regulations.
4. Contractor must verify all dimensions and level and report to the Architect before work is put at hand.
5. P.V. Joints or permanent ventilation and must be provided above all doors and windows where indicated.
6. D.P.C denotes one layer of bitumen felt to be provided under all walls above 150mm C.L.
7. All structures Road crossing to be finished to concrete to suit engineer's detail.
8. All floor is reinforced concrete work.



P. O. Box 19001-00501 NAIROBI
 Tel: 6611000/6612000
 Fax: 822078
 E-Mail: info@kenyaairports.co.ke

Project: PROPOSED REHABILITATION WORKS AT KITALE AIRSTRIP

Drawing Title: FLOOR LAYOUT PLAN AND ELEVATIONS

Dwg Title: KAA/OT/KITALE/1541/2018-2019

Drawn by: N. Obwoye
 Checked by: Eng. R. Mukiui

Approved by: Arch. Fred Odawo,
 General Manager (P&ES).

Dwg No. 009

Date: May 2019

Scale: 1:50

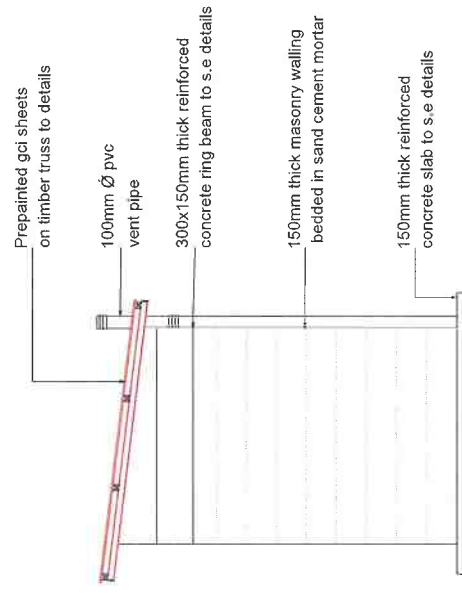

REAR ELEVATION SCALE 1:50

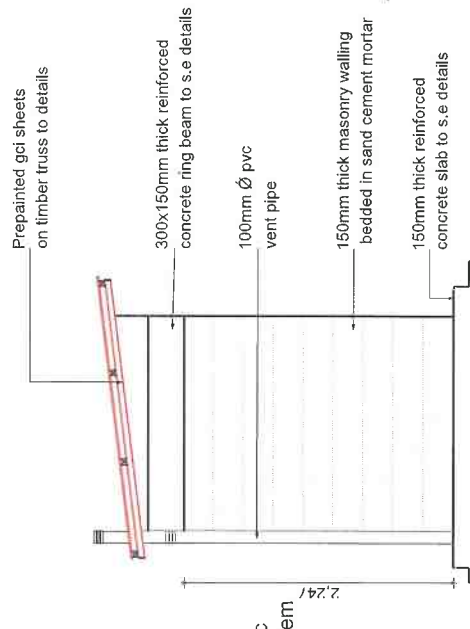

SECTION A/A SCALE 1:50

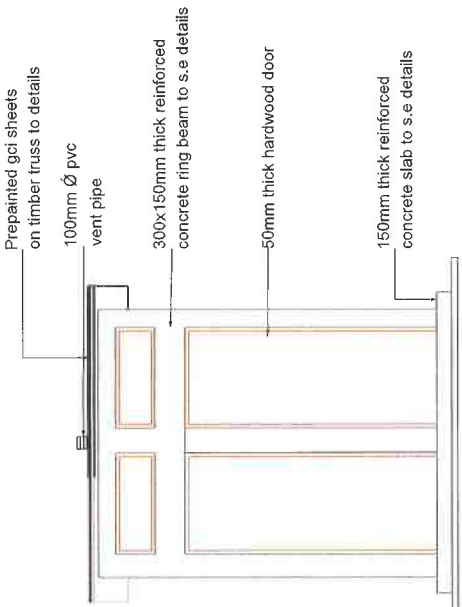

FRONT ELEVATION SCALE 1:50

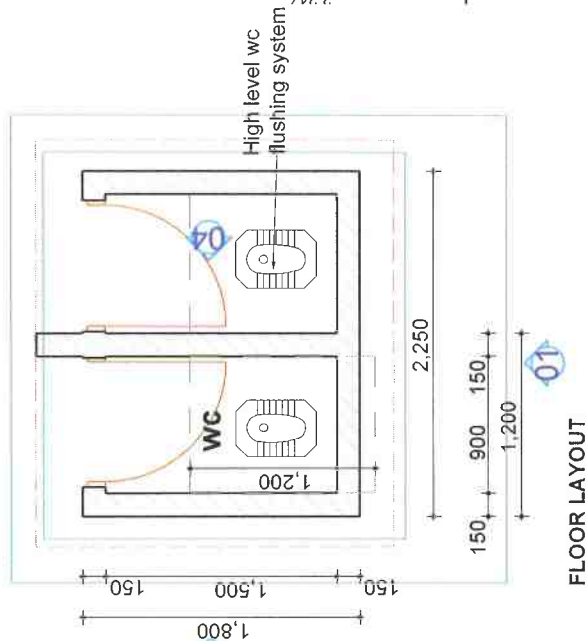

FLOOR LAYOUT

NOTE
 Contractor to provide 600 litres of high level water tank above the roof

KAA/OT/KITALE/1541/2018-2019



- NOTES**
1. All existing structures shall be demolished and replaced with new structures as indicated on the drawings.
 2. All new structures shall be constructed in accordance with the specifications and standards of the relevant authorities.
 3. All construction shall be carried out in accordance with the approved drawings and specifications.
 4. All construction shall be carried out in accordance with the approved drawings and specifications.
 5. All construction shall be carried out in accordance with the approved drawings and specifications.

- KEY**
- New Pavements
 - Re - Construction of existing Pavements

NO.	REVISIONS

RAA Royal Air Force Authority

15, KINGSWAY, LONDON, W2 7AF, UK
 TEL: 020 8756 5000
 FAX: 020 8756 5001
 WWW.RAA.CO.UK
 WEBSITE: WWW.RAA.CO.UK

PROPOSED REHABILITATION WORKS AT KITALE AIRSTRIP

Drawing No: **LONGITUDINAL PROFILE**

Designed by: **Zablon, Onhwaka Nelson Obwegwe**

Checked: **Eng. Raphael Mukuj**

Approved: **A/Ch. Fred Odawa**

GENERAL MANAGER (P&ES)

DATE	ISSUED
May 2018	NFS
PROJECT NO.	DRAWING NO.
MAK02018/1541/2018	002
REV.	MONTH

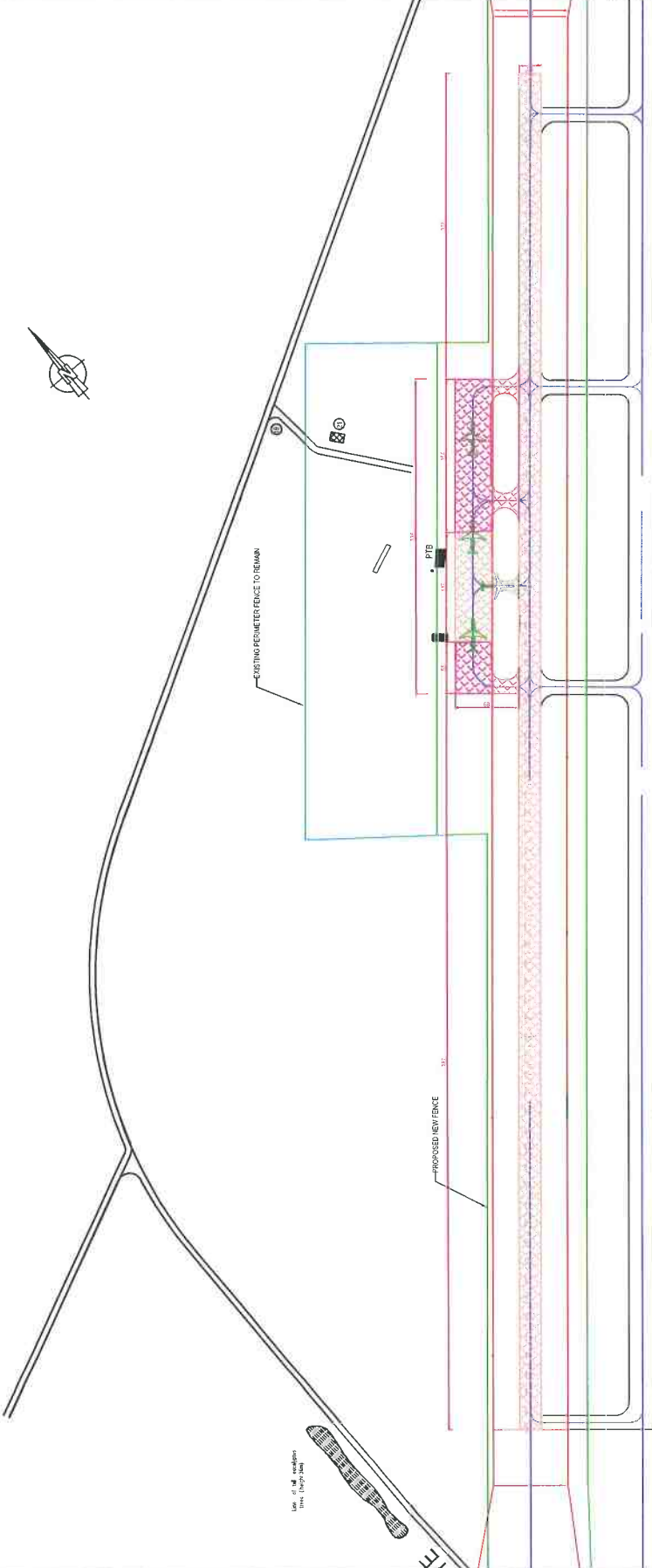

LAYOUT PLAN

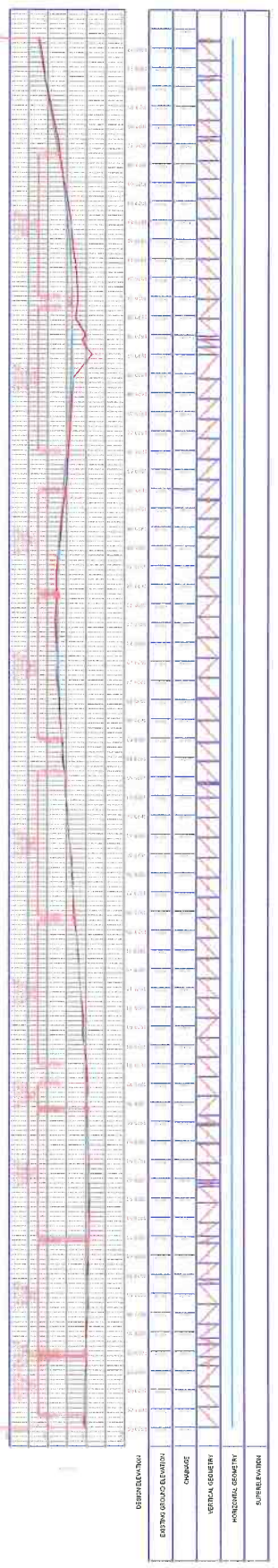

RUNWAY CENTER LINE PROFILE

KAA/OT/KITALE/1541/2018-2019

NOTES

1. This drawing is protected under the copyright act and cannot be used or reproduced in part or in whole without author's consent
2. All dimensions in mm unless stated should be read and not implied
3. All construction work to comply with latest K.B.S. code of practice, Local authority By-Laws and fire regulation.
4. P.V. details, penetrated, ventilation, and must be provided above all doors and windows where indicated.
5. D.P.C. denotes one layer of bituminous felt to be provided under all walls above 1.50m S.L.
6. Contractors must verify all dimensions and levels before commencing work, any discrepancy should be reported to the architect before work commences.

REVISIONS

Date	REVISION/ISSUE	No.



KENYA AIRPORTS AUTHORITY
P.O. BOX 19001 - 00501 NAIROBI
Tel: +254 20 6251000
Fax: +254 20 625278
Email: info@kenyaairports.com

PROPOSED REHABILITATION WORKS AT KITALE AIRSTRIP

Project: **STANDARD GATE 'B'**

Drawing Title: **STANDARD GATE 'B'**

Drawn: **N Obwoye.**

Checked: **Eng. Raphael Mukui.**

Approved: **Arch. Fred. Odawa**

--- GENERAL MANAGER (P&ES) ---

Date:	Scale:
May 2019.	NTS
Project No:	Drawing No.
MAA07/KITALE/1541/2018-2019	008
	NORTH

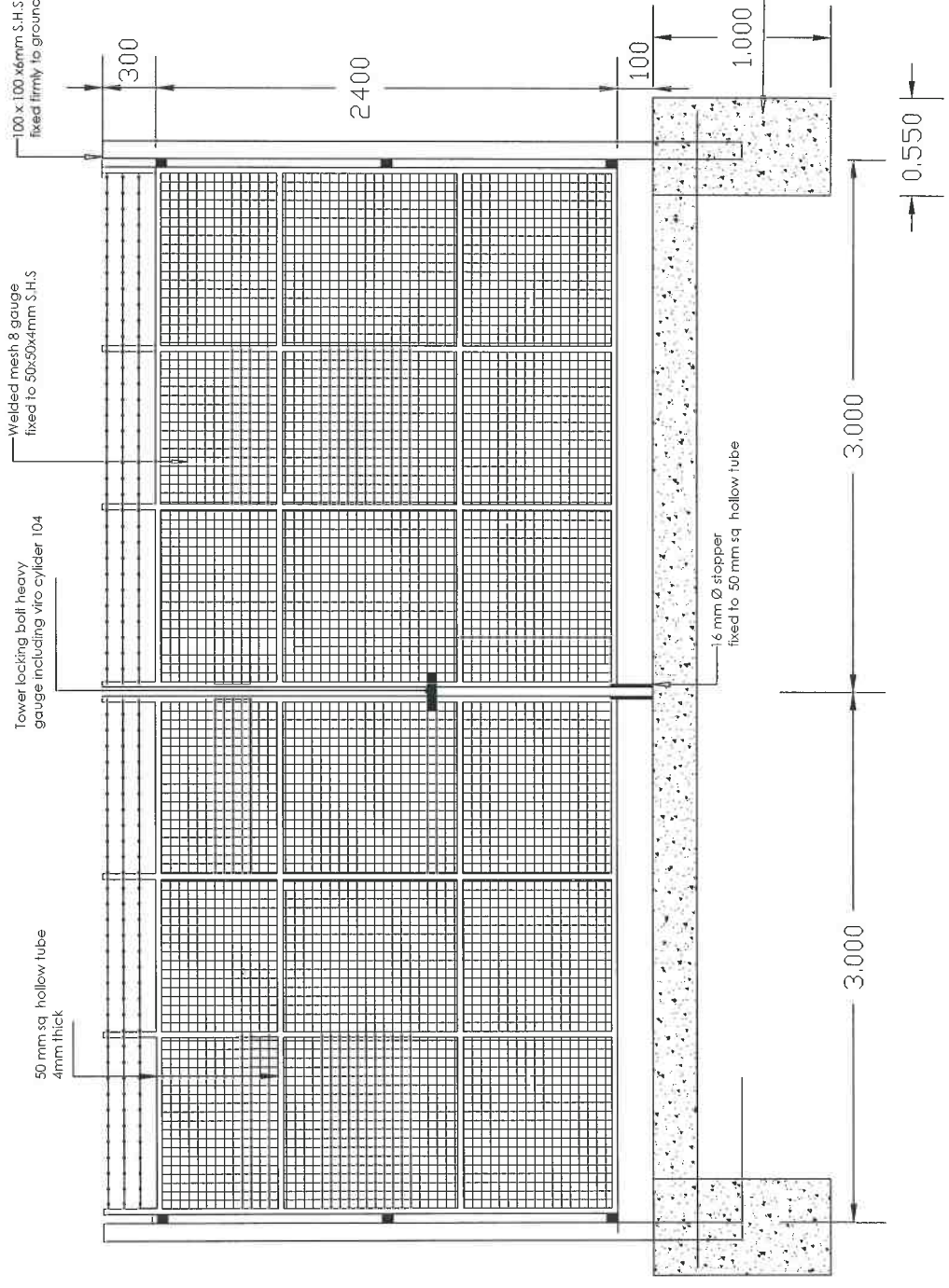

MAA07/KITALE/1541/2018-2019

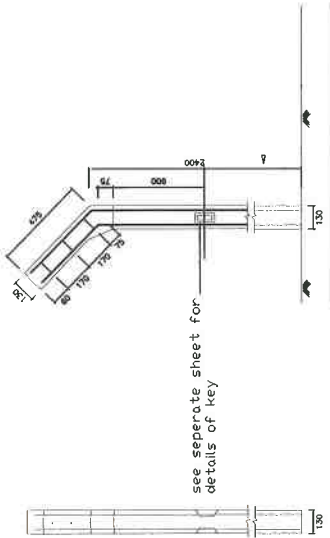

see separate sheet for details of key

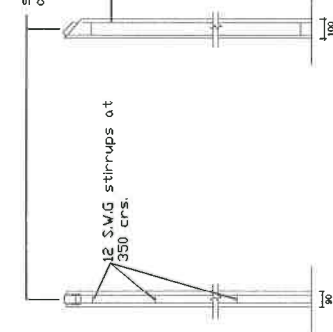

see separate sheet for details of key

NOTES:

- concrete shall be class 25 (M)
- minimum cover to reinforcement shall be 20mm
- 10mm chamfers shall be formed along all edges except on the key face

Joint buttered with 1:2 cement mortar

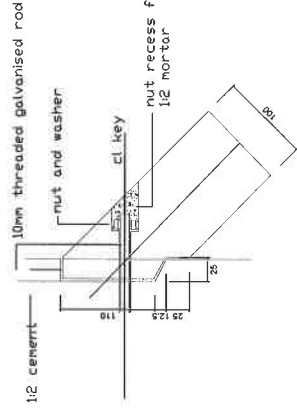

END VIEW SHOWING STRUT KEY

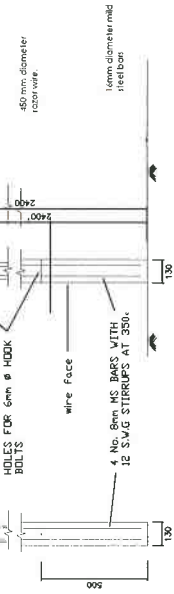

INTERMEDIATE POST DETAILS

STRAINING POST AND STRUT JOINT

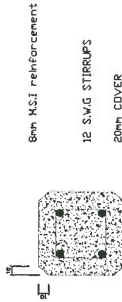

TYPICAL SECTION

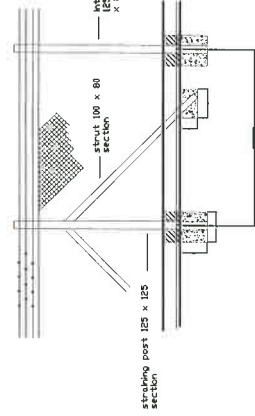

STRAINING POSTS

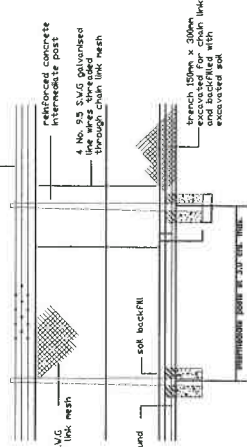

SECURITY FENCE

- This drawing is protected under the copyright act and cannot be used or reproduced in part or in whole without author's consent
- All dimensions in mm unless stated should be read and not measured.
- All construction work to comply with latest K.S.S code of practice or BS. Local Authority by laws and fire regulation.
- Contractor must verify all dimensions and levels before commencing work. All errors should be reported to the architect/engineer before work commences.

REVISIONS

Date	REVISION/ISSUE	No.

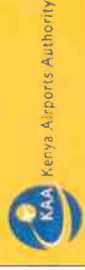

P.O BOX 19501 - 00501 NAIROBI
TEL: 822111/461009/461200
FAX: 822129/461009/461200
Email: info@kaa.go.ke
Website: www.kaa.go.ke

Project:

PROPOSED REHABILITATION WORKS AT KITALE AIRSTRIP

Drawing Title:
STANDARD FENCE DETAILS

Drawn: Nelson Obwoge
Checked: Eng. R. N. Mukui
Approved: Atch. Fred Odawa.

GENERAL MANAGER (P&ES)

Date:	May 2019
Scale:	NTS
Project No:	KA/OT/KITALE/1541/2018-2019
Drawing No:	006
Rev:	NORTH

KA/OT/KITALE/1541/2018-2019

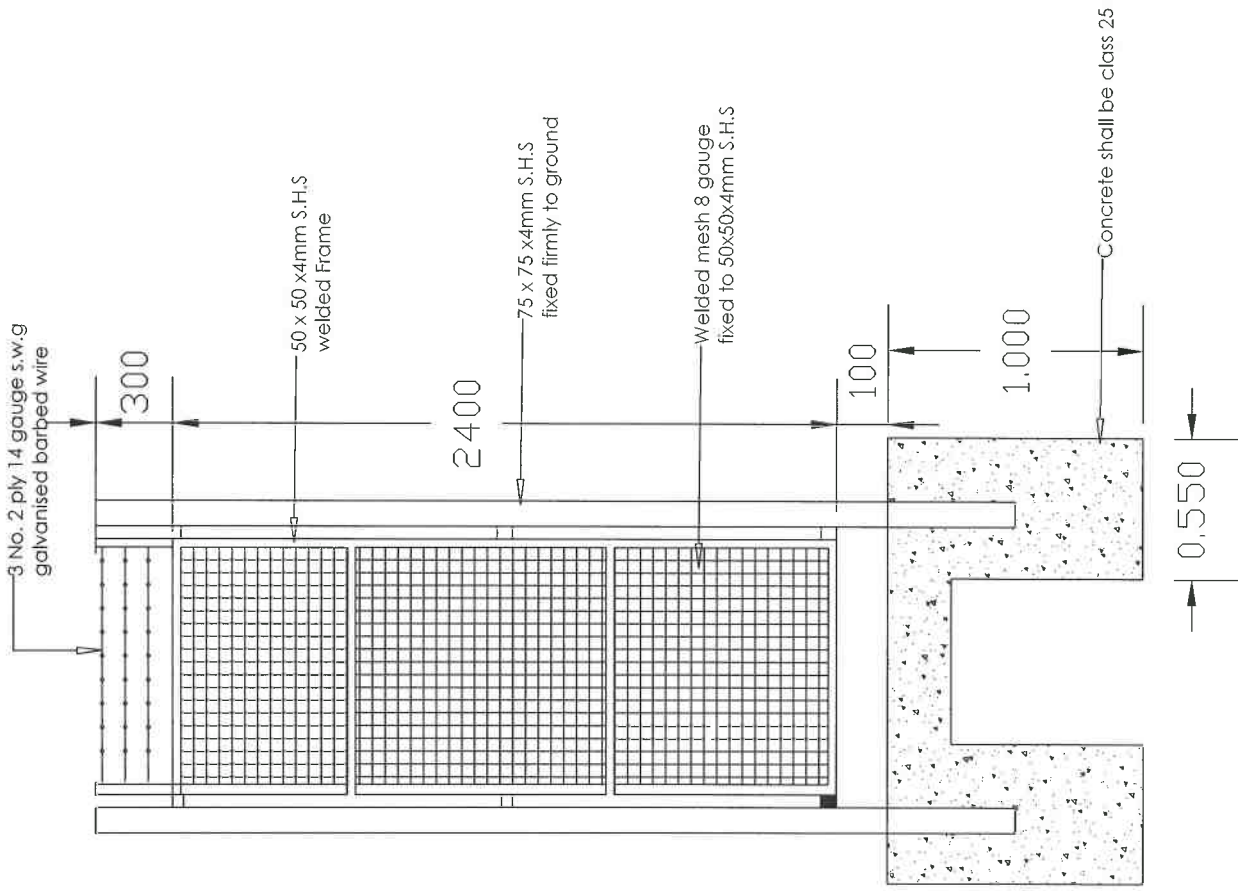

NOTES

1. This drawing is prepared under the responsibility of the drafter and cannot be used or reproduced in part or in whole without author's consent.
2. All dimensions in mm unless stated should be read and not measured.
3. All construction work to comply with latest E.C.S. and Kenya local authority (N) laws and the regulations.
4. Any capacitor permanent ventilation and must be indicated above all doors and windows where indicated.
5. D.P. is indicated on floor of this structure but to be provided under all walls above 150mm G.L.
6. Contractor must verify all dimensions and levels and report to the architect before work commences.

REVISIONS	
Date	REVISION/ISSUE

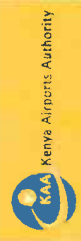

KENYA AIRPORTS AUTHORITY
 P.O. BOX 11601 - 00501 NAIROBI
 TEL: 254 20 3742100
 FAX: 254 20 3742978
 Email: info@kenyaairports.com

Project: **PROPOSED REHABILITATION WORKS AT KITALE AIRSTRIP**

Drawing title: **STANDARD GATE 'B'**

Drawn: **N.Obwoye.**

Checked: **Eng. Raphael Mukui.**

Approved: **Arch. Fred. Odawo**

GENERAL MANAGER (P&E)

Date	Scale
May 2019	NTS
Project No.	Drawing No.
KAAD/OT/KITALE/1541/2018	007



KAAD/OT/KITALE/1541/2018-2019

NOTES

1. The contractor shall be responsible for the design of the proposed works and shall ensure that the design is in accordance with the relevant standards and specifications.
2. The contractor shall ensure that the proposed works are constructed in accordance with the approved design and specifications.
3. The contractor shall ensure that the proposed works are constructed in accordance with the approved design and specifications.
4. The contractor shall ensure that the proposed works are constructed in accordance with the approved design and specifications.

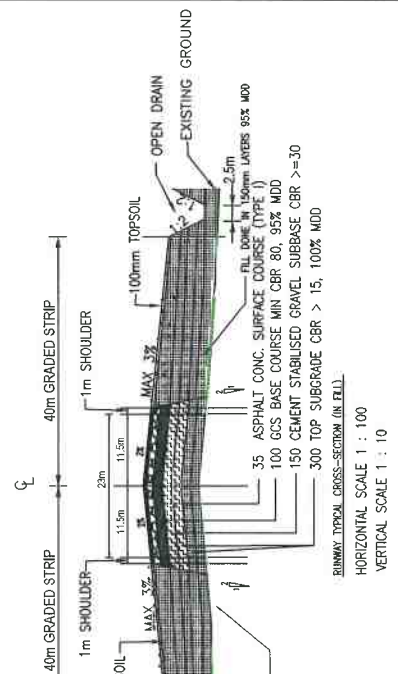

LAYER	THICKNESS	COMPACTION MOD
ASPHALT CONC. (TYPE I)	35mm	98%
GCS BASE COURSE	100mm	95%
CEMENT STABILISED GRAVEL SUBBASE	150mm	100%
TOP SUBGRADE CBR > 15	300mm	100%

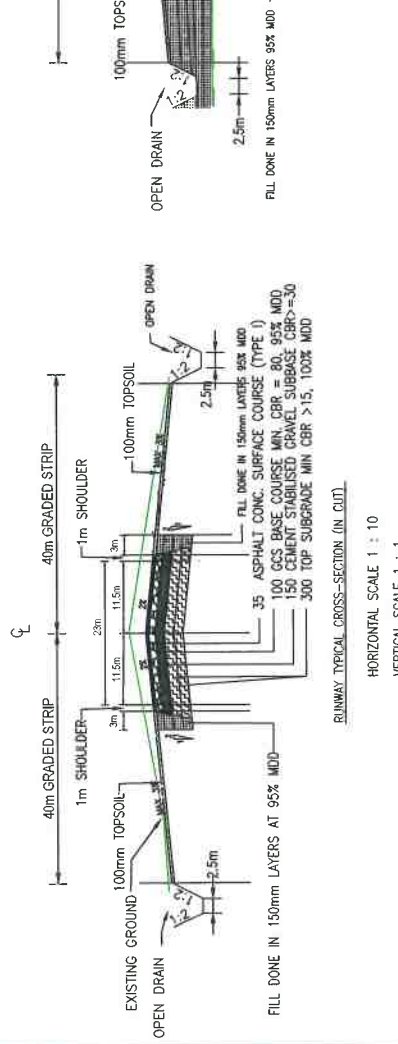

LAYER	THICKNESS	COMPACTION MOD
ASPHALT CONC. TYPE I	35mm	98%
GCS BASE COURSE	100mm	95%
CEMENT STABILISED GRAVEL SUBBASE	150mm	100%
TOP SUBGRADE CBR > 15	300mm	100%

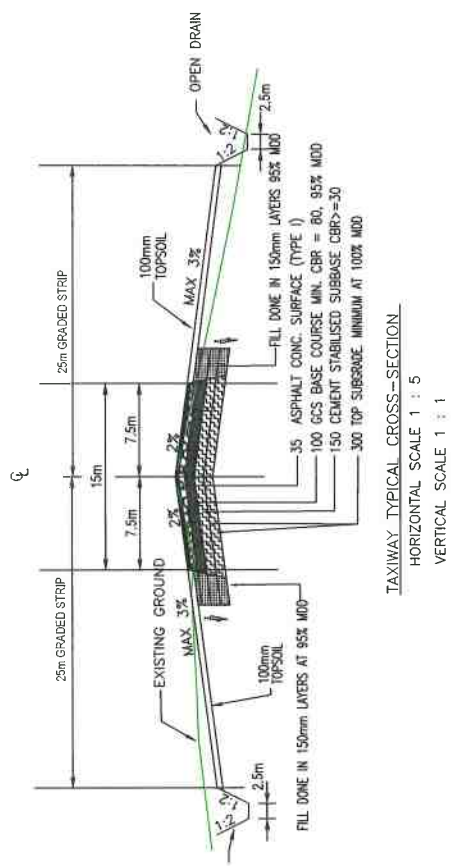

LAYER	THICKNESS	COMPACTION MOD
ASPHALT CONCRETE (TYPE I)	35mm	98%
GCS BASE COURSE	150mm	95%
CEMENT STABILISED SUBBASE	200mm	100%
TOP SUBGRADE CBR > 15	300mm	100%

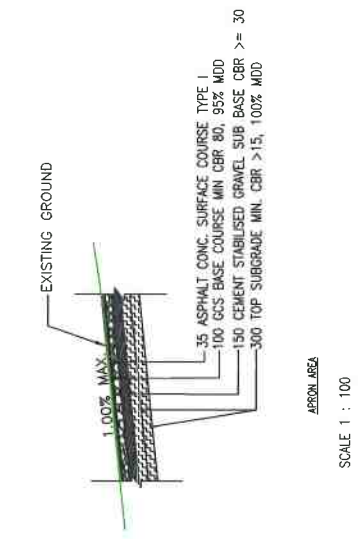

LAYER	THICKNESS	COMPACTION MOD
ASPHALT CONCRETE (TYPE I)	35mm	98%
GCS BASE COURSE	100mm	95%
CEMENT STABILISED GRAVEL SUBBASE	150mm	100%
TOP SUBGRADE CBR > 15	300mm	100%

NO.	REVISIONS
1	ISSUED FOR TENDERS



PROPOSED REHABILITATION WORKS AT KITALE AIRSTRIP

Client: **Nelson Obwoye**
 Design: **Eng. Raphael Muki**
 Checked: **Arch. Fred Odawa**
 Date: **May 2019**
 Project No: **MA/PA/NT/15/10/2018**
 Drawing No: **94**
 Scale: **AS SHOWN**

CAA/OT/KITALE/1541/2018-2019

NOTES

1. This drawing is protected under the copyright act and cannot be used or reproduced in part or in whole without the owner's consent.
2. All dimensions in mm unless stated in meters.
3. All construction work to comply with latest K.A.A. code of practice or B. Local Authority by laws and regulations.
4. Contractor must verify all dimensions and levels before commencing work. Any discrepancies should be reported to the architect/engineer before work commences.

REVISIONS	
Date	REVISION / ISSUE



Kenya Airports Authority
 P. O. BOX 19001 - 00501 NAIROBI
 TEL: 8227111/641000/6441200
 FAX: 822078/8227324
 E-MAIL: kaa@kaa.go.ke
 Website: www.kenyaairports.co.ke

Project PROPOSED REHABILITATION WORKS AT KITALE AIRSTRIP	
Drawing Title PROJECT SIGNBOARD	
Drawn Nelson Obwoye	
Checked Eng. Raphael Mukui	
Approved Arch. Fred Odawa	
GENERAL MANAGER (P&ES)	
Date May 2017	Scale N.T.S.
Project No MAA/OT/TALE/1541/2018-2019	Drawing No 005
Rev	NOPTH

CLIENT:

KENYA AIRPORTS AUTHORITY (KAA)

PROJECT: PROPOSED REHABILITATION WORKS AT KITALE AIRSTRIP

PROJECT No: KAA/OT/KITALE/1541/2018-2019

EMPLOYER: MANAGING DIRECTOR - KAA
 P. O. BOX 19001 -00501 NAIROBI

ENGINEER: GENERAL MANAGER (P & ES) - KAA
 P. O. BOX 19001 -00501 NAIROBI

CONTRACTOR:

SUB-CONTRACTOR:

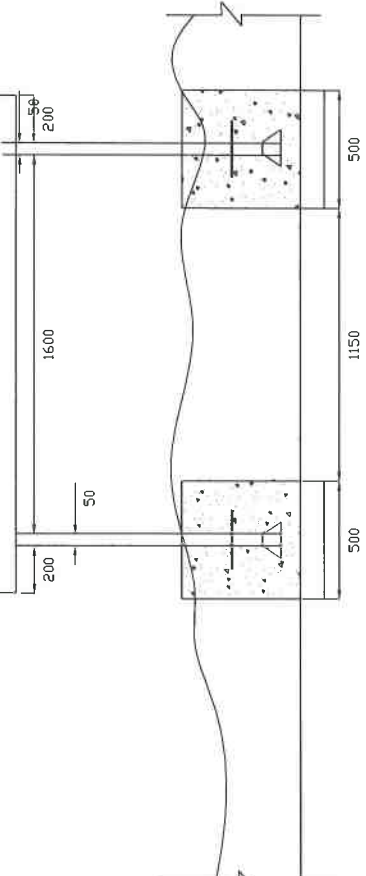
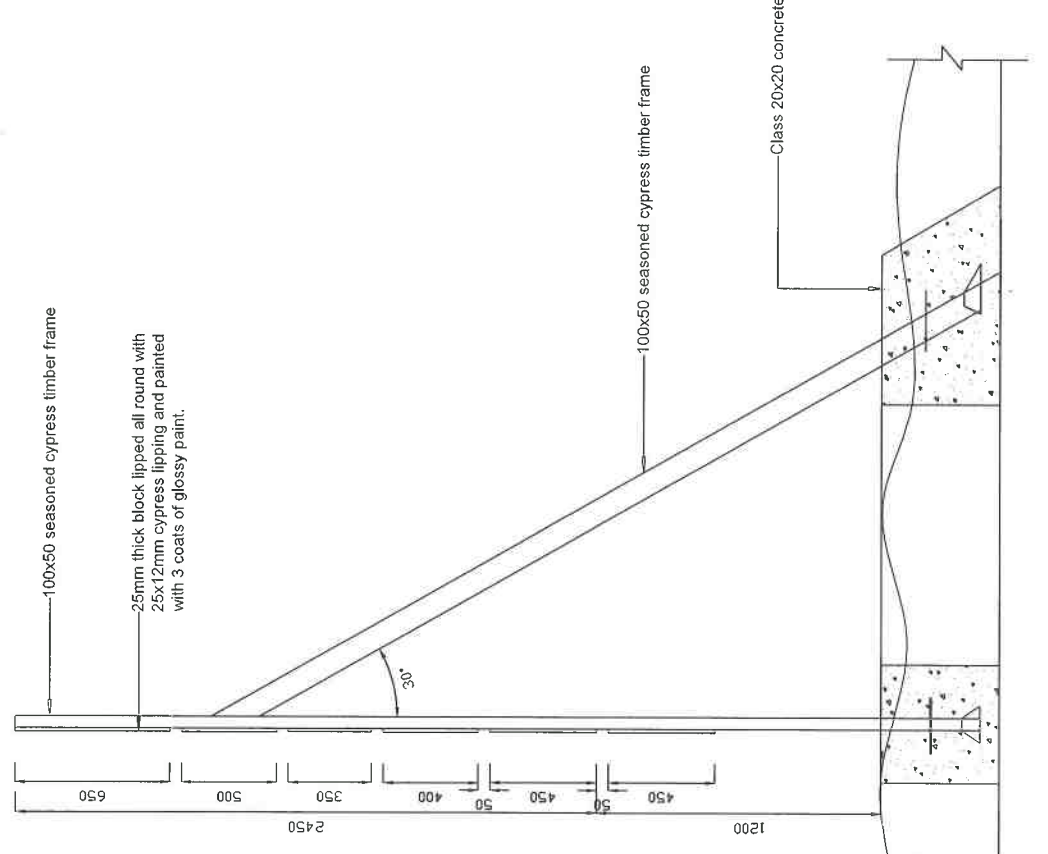

CAA/OT/KITALE/1541/2018-2019

NOTES

1. This drawing is prepared under the supervision of the Engineer in Charge and shall be used for construction works without further contact with the Engineer in Charge.
2. All dimensions are in meters unless stated otherwise.
3. All construction work to be completed with latest 1:1 scale drawings and approved by the Engineer in Charge.
4. Construction methods shall be as per the approved drawings and specifications. Any deviation from the approved drawings shall be approved by the Engineer in Charge before work commences.

KEY

-  New Pavements
-  Re-Construction of existing Pavements

REVISIONS		
NO.	DESCRIPTION	DATE



Kenya Airport Authority
 P.O. Box 19001 - 00201 NAIROBI
 P.O. Box 42507 - 00102 NAIROBI
 Website: www.kaa.co.ke

PROPOSED REHABILITATION WORKS AT KITALE AIRSTRIP

Drawing Title: **WORKING LAYOUT PLAN**

Design by: **Zablon Onhwel**
 Checked by: **Nelson Obwoge**
 Approved by: **Eng. Raphael Mukiui**
 Architect: **Arch. Fred Odawo**

GENERAL MANAGER (T&ES)		
NO.	DATE	DESCRIPTION

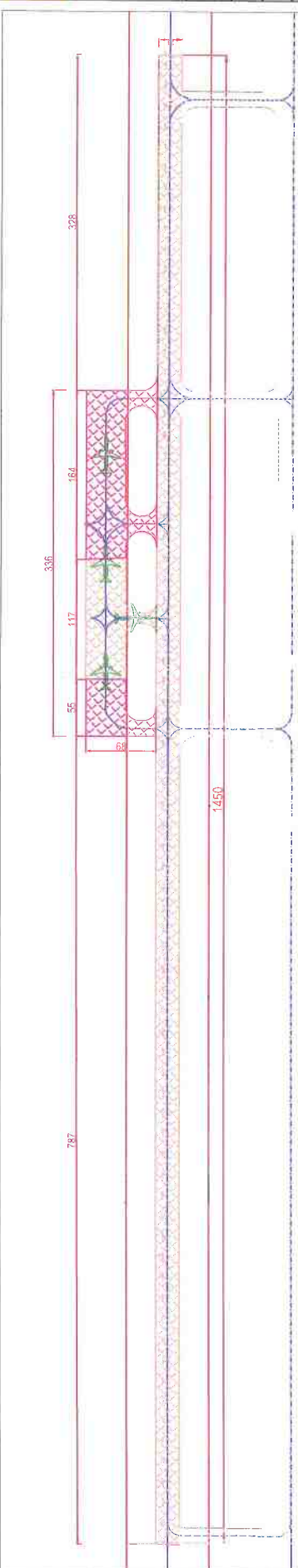
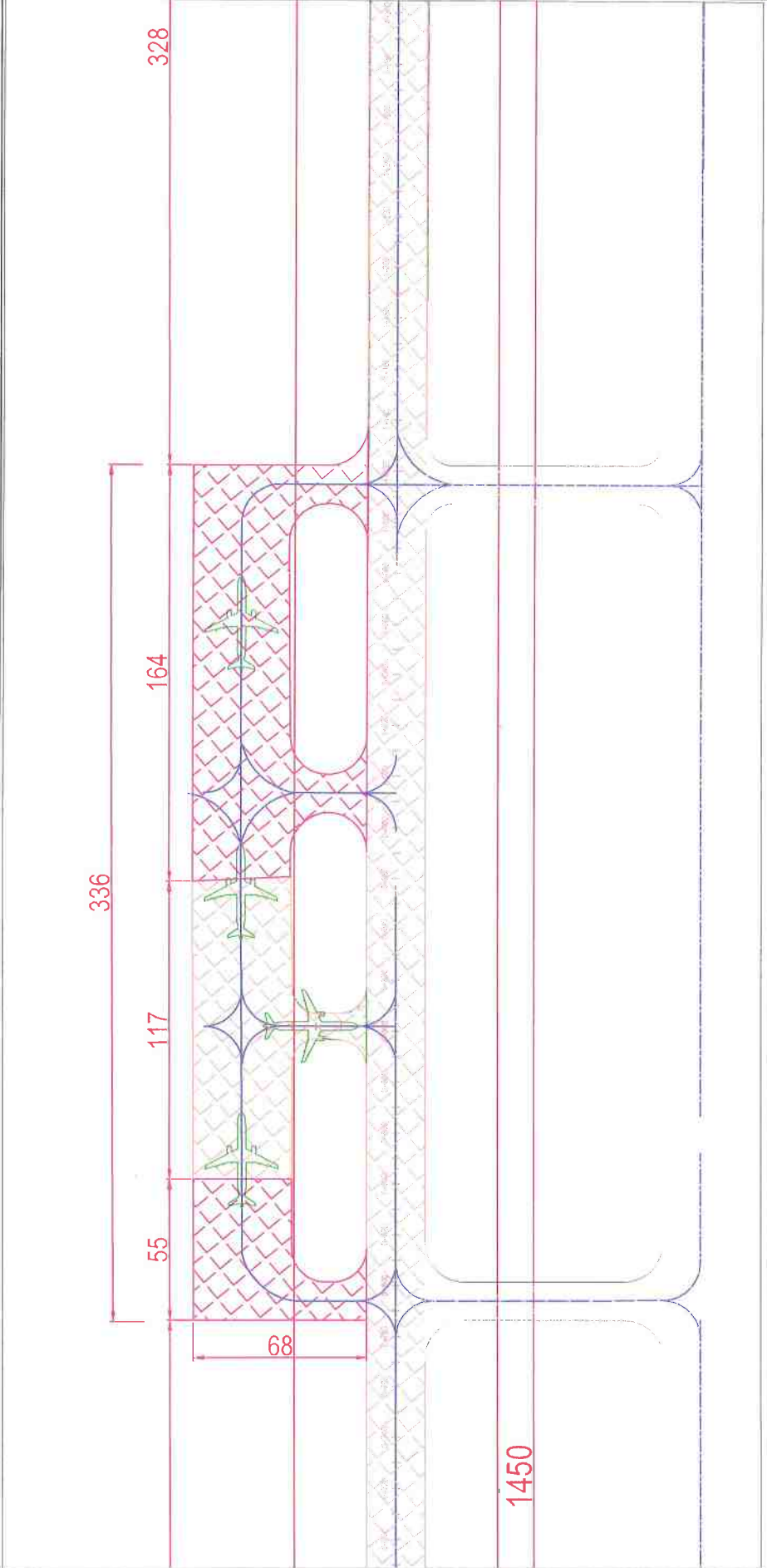

CAA/OT/KITALE/1541/2018-2019

